

Inclination sensors

Measuring range $\pm 15^\circ$, $\pm 30^\circ$, $\pm 60^\circ$, 360°

CANopen® / Profibus-DP

GNAMG



GNAMG with mounting plate 99 x 60 mm

Technical data - electrical ratings

Voltage supply	10...30 VDC
Reverse polarity protection	Yes
Consumption w/o load	≤ 100 mA (24 VDC)
Initializing time typ.	250 ms after power on
Interfaces	CANopen®, Profibus-DPV0
Device adress	Rotary switches in bus cover
Measuring range	$\pm 15^\circ/\pm 30^\circ/\pm 60^\circ$ (two-dimensional) 360° (one-dimensional)
Resolution	0.001..1 ° (measuring range 15°, 30°, 60°) 0.1..1 ° (measuring range 360°)
Accuracy (+25 °C)	$\pm 0.1^\circ$ (measuring range 15°) $\pm 0.2^\circ$ (measuring range 30°, 60°, 360°)
Settling time max.	0.5 s
Measuring cycle	10 Hz
Code	Binary
Interference immunity	DIN EN 61000-6-2
Emitted interference	DIN EN 61000-6-4
Programmable parameters	Resolution Preset and offset
Diagnostic function	Parameter error
Status indicator	DUO-LED integrated in bus cover
Approval	UL approval / E63076

Features

- Inclination sensor / CANopen® / Profibus
- Measuring range two-dimensional: $\pm 15^\circ$, $\pm 30^\circ$, $\pm 60^\circ$
- Measuring range one-dimensional: 360°
- Resolution: 0.001° to 1°
- Accuracy: $\pm 0.1^\circ$ to 0.2°
- Programmable parameters
- Protection max. IP 67

Optional

- Stainless steel

Technical data - mechanical design

Dimensions mounting plate	99 x 60 x 5 mm
Protection DIN EN 60529	IP 66 (connector M12), IP 67 (cable gland)
Materials	Bus cover: zinc die-cast Base plate: aluminium
Operating temperature	-25...+85 °C -40...+85 °C (optional: only cable gland)
Relative humidity	95 % non-condensing
Resistance	DIN EN 60068-2-6 Vibration 10 g, 16-2000 Hz DIN EN 60068-2-27 Shock 200 g, 6 ms
Weight approx.	250 g
Connection	Cable gland Connector M12, 4-pin Connector M12, 5-pin

Inclination sensors

Measuring range $\pm 15^\circ$, $\pm 30^\circ$, $\pm 60^\circ$, 360°

CANopen® / Profibus-DP

GNAMG

Installation position

Measuring range 15° , 30° , 60°

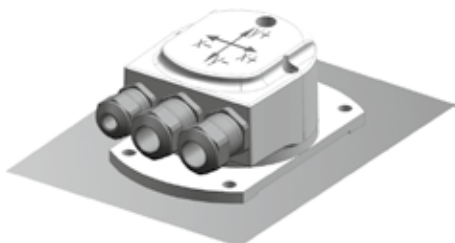

The two-dimensional inclination sensor with a configured range of 15° , 30° and 60° must be mounted with the base plate in horizontal position, i.e. parallel to the horizontal line. The inclination sensor may also be installed upside down, i.e. turned by 180° .

The sensor can be inclined both towards the X and Y axis at the same time. For each axis a separate measured value is provided. Default on delivery the inclination sensor will apply the selected sensing range to both axis, for example $\pm 15^\circ$ with the zero passage being precisely in the horizontal line.

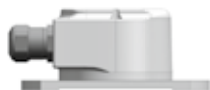

Default 0°



Measured inclination -30°



Default 0°



Measured inclination 30°

Measuring range 360°

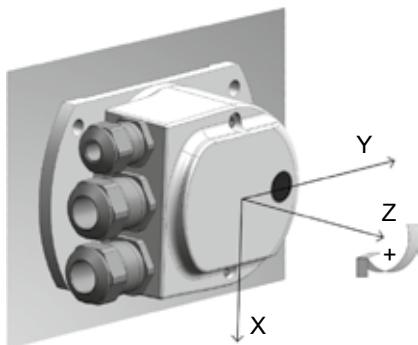

The inclination sensor with a configured range of 360° must be mounted in a way that the X-axis as in the following sketch is directed in a parallel way towards gravity. The deflection may not be more than $\pm 3^\circ$.

Please note also that the inclination sensor must evenly touch the contact surface and during inclination/rotation must not be subject to any inclination in X- or Y-direction since this would have a negative impact on the measuring accuracy.

The 360° inclination sensor default position is 0° as shown in the following illustration but may be configured at will by help of the preset function. The measuring direction may also be inverted. Default on delivery the inclination sensor's sensing direction is clockwise from $0 \dots 360^\circ$, in case of active inversion counter-clockwise.



Default 0°

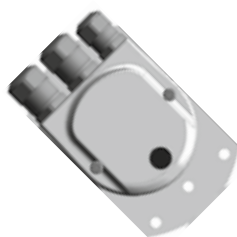

Measured inclination 45°

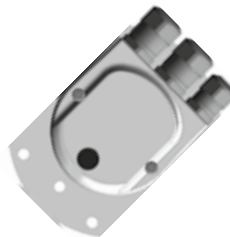

Measured inclination 135°



Measured inclination 180°

Inclination sensors

Measuring range $\pm 15^\circ$, $\pm 30^\circ$, $\pm 60^\circ$, 360°
 CANopen® / Profibus-DP

GNAMG

Dimensions

GNAMG - cable gland

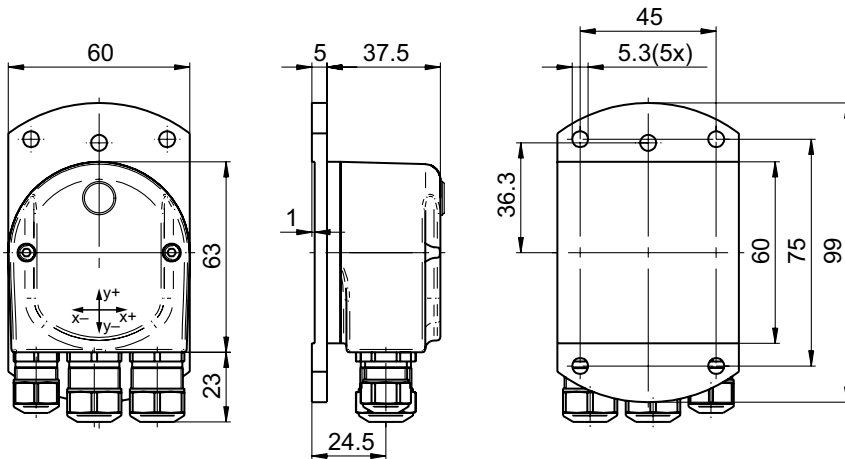

CANopen® - M12

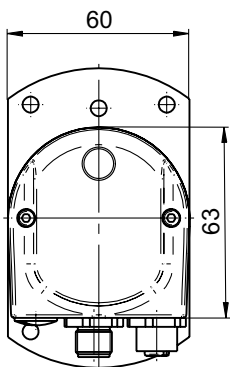

Profibus connector M12

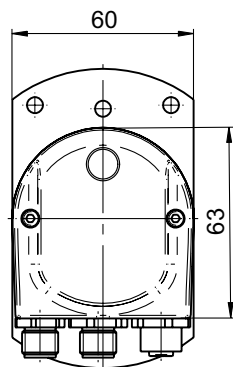

Mounting version

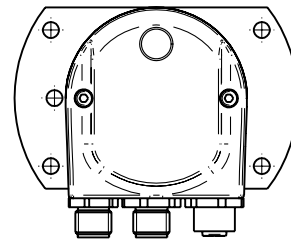

Inclination sensors

Measuring range $\pm 15^\circ$, $\pm 30^\circ$, $\pm 60^\circ$, 360°

CANopen® / Profibus-DP

GNAMG

View inside bus cover

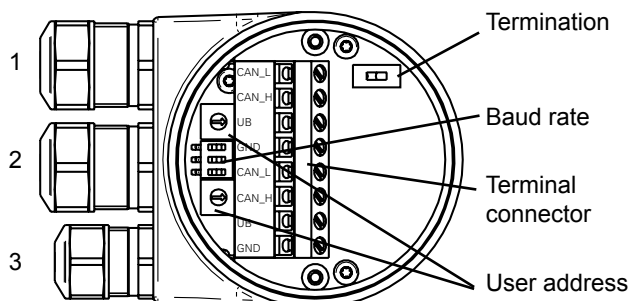

Cable: 1, 2 = $\varnothing 8-10$ mm (-40-85 °C) / $\varnothing 5-9$ mm (-25-85 °C)
 Cable: 3 = $\varnothing 4.5-6$ mm (-40-85 °C) / $\varnothing 3-6$ mm (-25-85 °C)

Features - CANopen®

Bus protocol	CANopen®
Device profile	CANopen® - CiA DSP 406, V 3.0 (Device Class 2, CAN 2.0B)
Operating mode	Event-triggered, Time-triggered Remotely-requested Sync (cyclic), Sync (acyclic)
Preset/Offset	Parameter for setting the inclination sensor to a requested position value assigned to a defined shaft position of the system. Storage non-volatile.
Rotating direction	Parameter for defining the inclination direction in which there have to be ascending or descending position values.
Scaling	Scaling „enabled“ will consider the parameterized preset/offset.
Resolution	Resolution parametering 0.001...1° (15°/30°/60°) 0.1...1° (360°)
Node ID monitoring	Heartbeat or Nodeguarding
Default	50 kbit/s, Node ID 1

Bus cover - CANopen®

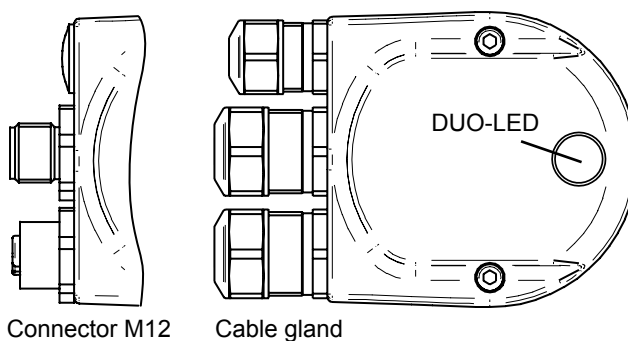

Connector M12

Cable gland

Termination



ON = final user
 OFF = user X

User address (identifier)

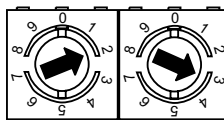

Defined by rotary switch.
 Example: User address 23

Baud rate

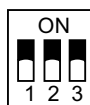

Baud rate	Dip switch position		
	1	2	3
10 kbit/s	OFF	OFF	OFF
20 kbit/s	OFF	OFF	ON
50 kbit/s	OFF	ON	OFF
125 kbit/s	OFF	ON	ON
250 kbit/s	ON	OFF	OFF
500 kbit/s	ON	OFF	ON
800 kbit/s	ON	ON	OFF
1 MBit/s	ON	ON	ON

If the user address is 00 the baud rate and Node ID are programmable via CAN bus.

Inclination sensors

Measuring range $\pm 15^\circ$, $\pm 30^\circ$, $\pm 60^\circ$, 360°
CANopen® / Profibus-DP

GNAMG

View inside bus cover

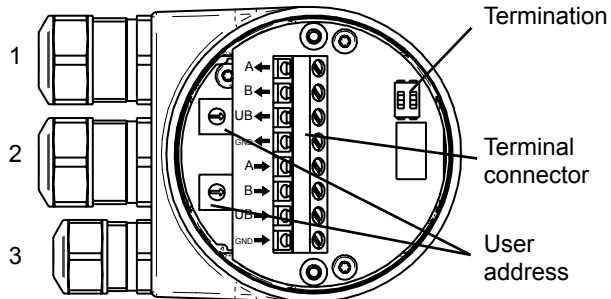

Cable: 1, 2 = $\varnothing 8-10$ mm (-40-85 °C) / $\varnothing 5-9$ mm (-25-85 °C)
Cable: 3 = $\varnothing 4.5-6$ mm (-40-85 °C) / $\varnothing 3-6$ mm (-25-85 °C)

Features - Profibus-DPV0

Bus protocol	Profibus-DPV0
Device profile	Device Class 2
Cyclic data exchange	Communication in line with DPV0
Input data	Position value.
Output data	Preset and Offset (only $15^\circ/30^\circ/60^\circ$).
Preset/Offset	Parameter for setting the inclination sensor to a requested position value assigned to a defined shaft position of the system. Storage non-volatile.
Rotating direction	Parameter for defining the inclination direction in which there have to be ascending or descending position values.
Scaling	Scaling „enabled“ will consider the parameterized preset/offset.
Resolution	Resolution parametering 0.001...1° ($15^\circ/30^\circ/60^\circ$) 0.1...1° (360°)
Default	User address 00 Termination OFF

Bus cover - Profibus-DPV0

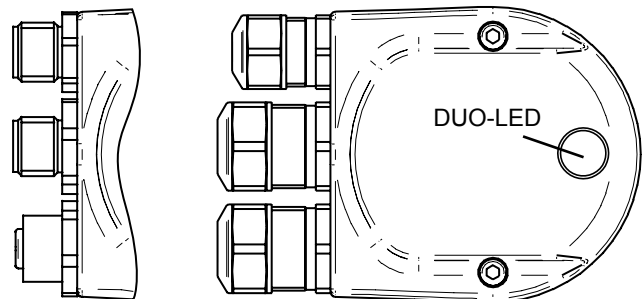

Connector M12

Cable gland

Termination

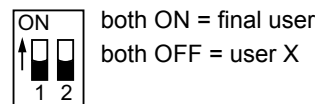

User address (identifier)

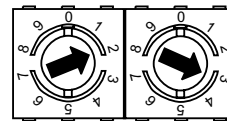

Defined by rotary switch.
Example: User address 23